

KORAMIC

Clay Roof Tiles. Designed for Living.



Natural Red (600)



Red Matt Engobe (602)



Rustic (872)



Matt Slate Grey (703)



Noble Black Engobe (745)



Black Glazed (738)

Madura

The new range of large-format clay roof tiles

- > Combines fast placing and flexibility with the natural beauty and durability of clay roof tiles.
- > Perfect for any type of renovation or large-scale building project.



NARVIK

What's flexible, big & fast and elegant?

- Variable lath distance between 335 and 370mm.
- Complete range of accessories, colours and finishing.
- Ideal for any type of renovation.



Flexible

- Variable covering width 237-240 mm
- Economical and fast placing.
- Large format 11.3 to 12.6 piece/m².
- Perfect for large surfaces & major building projects.

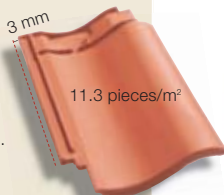

Big & Fast

- The authentic look of the deep-curved interlocking S-tile.
- The natural beauty of clay roof tiles.
- A modern touch.



Elegant



Your local Koramic stockist

Koramic Roofing Products

Ter Bede Business Center
B-8500 Kortrijk (Belgium)
T: +32 (0)56 26 43 31
F: +32 (0)56 26 43 32
info@koramic-rooftiles.com
www.koramic-rooftiles.com

EX EN T009 0002/0304

Clay Roof Tiles. Designed for Living.

NARVIK

KORAMIC

Clay Roof Tiles. Designed for Living.

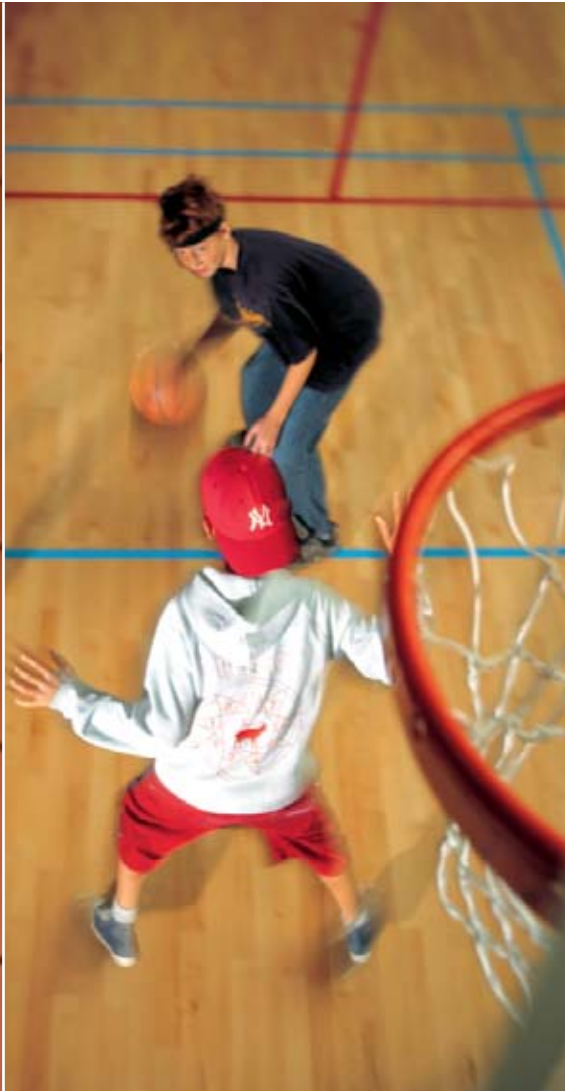

Large-format tile MADURA

Deep curved interlocking S-tile.

11.3 pieces/m²

335 mm

370 mm

New

Can be laid on a variable batten distance between 335 mm and 370 mm.

NARVIK

Large-format tile MADURA

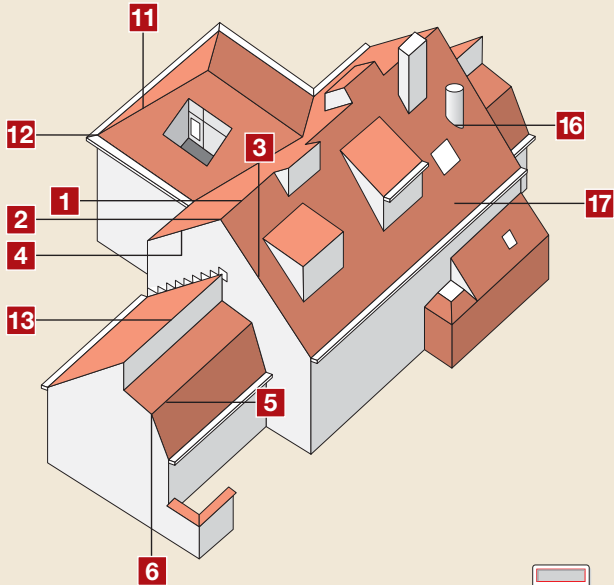

DIMENSIONS



Effective Cover Width

Length/Gauge	± 335-370 mm
Width/Gauge	± 237-240 mm

Overall Size

Length	± 457 mm
Width	± 287 mm

TECHNICAL DATA



Data	Brand: Narvik
	Model: Large-format Madura
Minimum pitch	10° with a lath distance = 335mm (*) 25° with a lath distance = 370mm (*)
Tiles/m ²	± 11.3-12.6
Weight/tile	± 3.6 kg
Weight/m ²	± 40.7-45.4 kg
Crushing strength	> 1200 N (EN538)
Water impermeability	≤ 0,50 cm ³ /cm ² .d (EN539-1)
Frost resistance	guarantee for 30 years
Batten size	50 x 25 mm (BS 1202)
Nails	copper, steel or aluminium alloy (BS 1202)

(*) For intermediate pitches or lath distances please contact us.

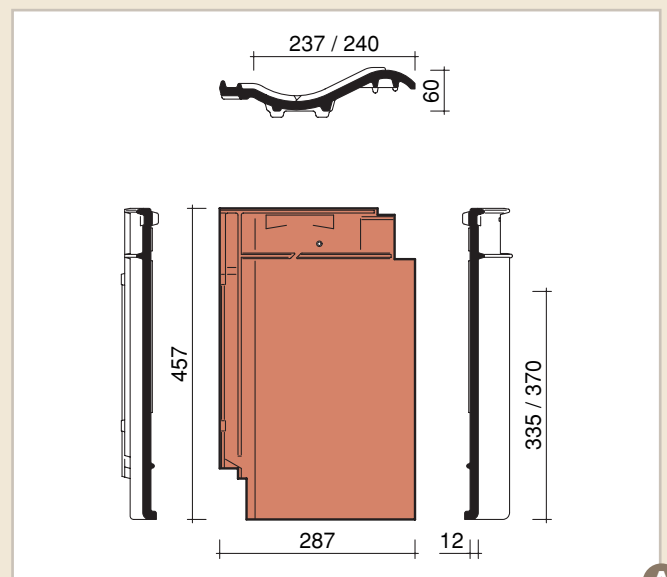

Manufactured to NEN-EN1304

ROOF DETAILS

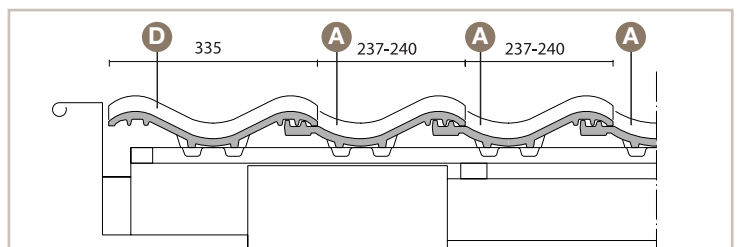
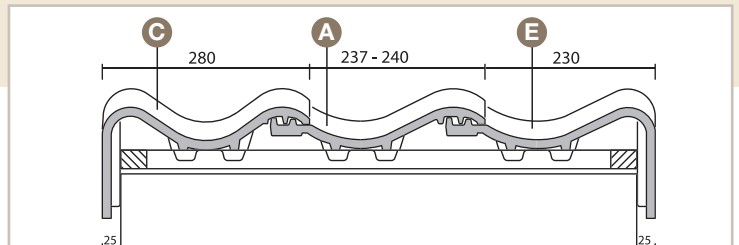
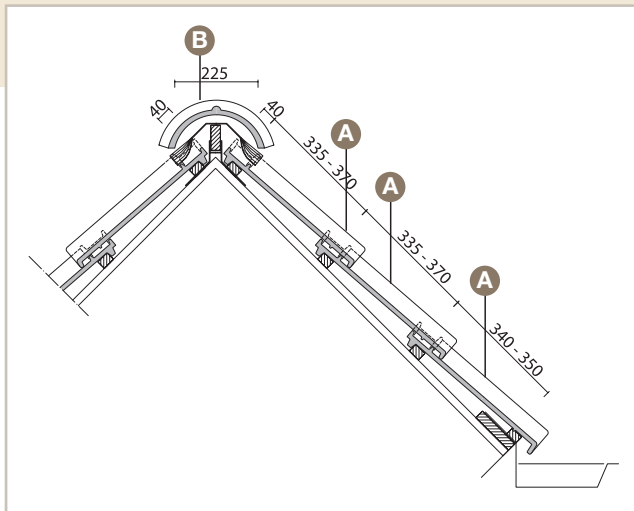
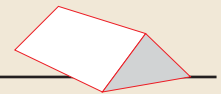

This document does not imply a contract. The colours used in this folder show the natural tint of our clay roof tiles subject to the limitations of the printing process. As clay roof tiles are natural materials, slight variations in colour may occur between batches of tiles, we recommend that they should be taken from several pallets at the same time and mixed at random on the roof. Koramic reserves the right to alter the range and the technical data. Dimensions are approximate.

RIDGES

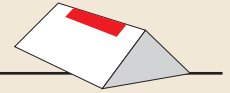

Tegelen 225mm interlocking half round ridge (3/m)

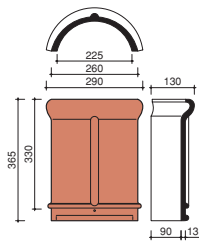

Ref. No. 1200

B 1

Tegelen 225mm interlocking half round starter ridge with end cap

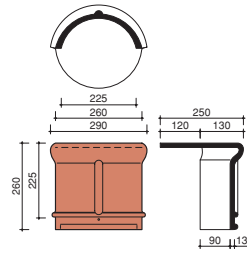

Ref. No. 1210

2

Tegelen 225mm interlocking half round end ridge with end cap

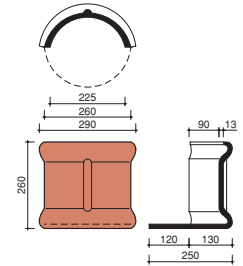

Ref. No. 1220

2

HIP TILES

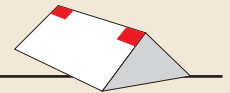

Tegelen 225mm interlocking half round begin hip tile

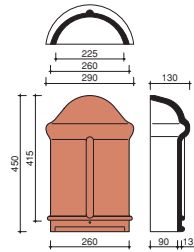

Ref. No. 1260

2

Tegelen tapered hip tile (3/m)

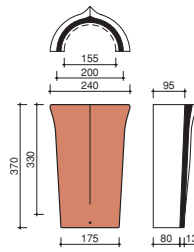

Ref. No. 3100

11

Tegelen begin tapered hip tile

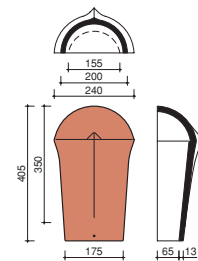

Ref. No. 3110

12

VERGE TILES

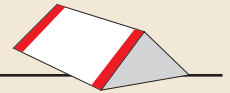

Madura Narvik cloaked verge tile
left hand (2,7/m)

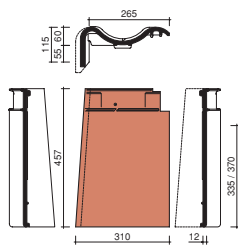

Ref. No. 7080

C 3

Madura Narvik cloaked verge tile
right hand (2,7/m)

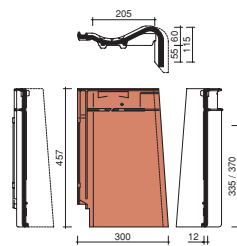

Ref. No. 7090

E 4

Madura Narvik Left hand verge/
Double roll tile (2,7/m)

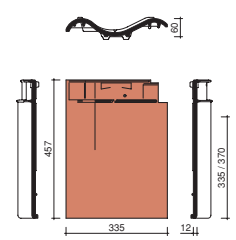

Ref. No. 8050

D 3

VARIOUS FITTINGS

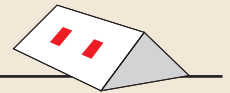

Madura Narvik ventilation tile
with ceramic grid

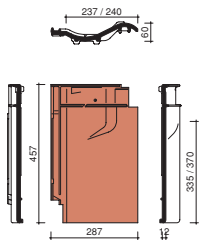

Ref. No. 8600

17

Madura Narvik steam exhausting tile
Ø 100 mm

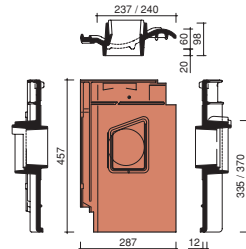

Ref. No. 8720

16

Tegelen cap for steam exhausting tile
Ø 100 mm

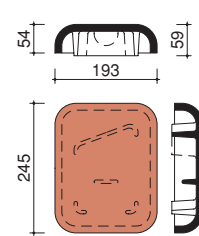

Ref. No. 8760

16